



SEK-2
Instruction Manual
for
Stylus Evaluation Kit

Manufactured by
SHURE BROTHERS INCORPORATED
222 Hartrey Avenue
Evanston, Illinois 60204

TABLE OF CONTENTS

| | PAGE |
|--|------|
| I. INTRODUCTION | 1 |
| II. INSTALLATION AND ADJUSTMENT | 2 |
| A. Stylus Preparation | 2 |
| B. Microscope Set-up | 3 |
| III. STYLUS EVALUATION | 4 |
| IV. STYLUS PRESERVATION | 8 |
| V. ADDENDA | 9 |
| A. Replacement Parts | 9 |
| B. 240-Volt Operation | 9 |
| C. Guarantee | 9 |
| D. Shipping Instructions | 9 |

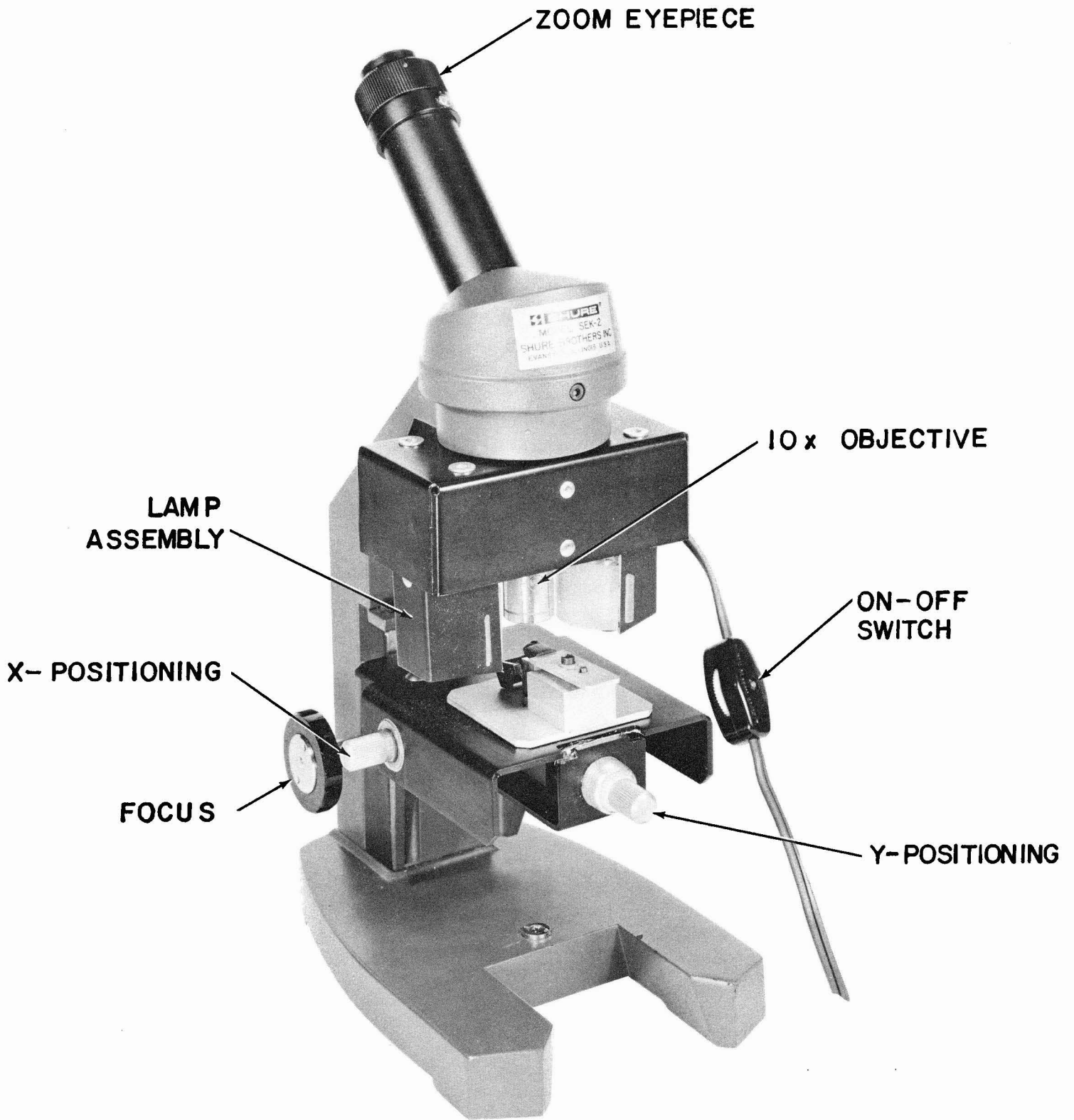

MODEL SEK-2 MICROSCOPE

I. INTRODUCTION

The Shure Model SEK-2 Stylus Evaluation Kit consists of a high-quality microscope designed to evaluate the condition of phonograph cartridge stylus tips. The SEK-2 provides a visual indication of the amount of wear on stylus tips, enabling the customer to judge the necessity for replacing his stylus.

The SEK-2 includes a 100-200x monocular microscope featuring coated optics, 10 to 20x zoom eyepiece, 10x objective, rigid "L" stand construction, inclined eyetube, precision focus control with end-of-focus slip clutch, and tension control to maintain focus. In addition, the microscope has x- and y-plane horizontal stage positioning controls, and locating screws and hole on the stage to facilitate stylus positioning. The SEK-2 also includes a two-lamp stage illuminator, stylus mounting block, stylus mounting plate, pliable material for mounting other than Shure styli, dust cover, pencil-type flashlight (uses two penlite batteries), and two light diffusers for the lamp assembly.

The Shure SEK-2 Microscope is a high-quality optical instrument. Reasonable care will insure years of excellent service. Keep the Microscope covered when not in use.

II. INSTALLATION AND ADJUSTMENT

A. Stylus Preparation

The stylus cannot be evaluated properly unless the stylus tip is clean. To clean the stylus, use a camel's-hair brush (No. 2 size or smaller) dipped lightly in grain (ethyl) alcohol or alcohol-distilled water solution; one part alcohol to three parts distilled water is recommended. (WARNING: Commercial record or stylus cleaning solutions may cause corrosion and permanent stylus damage.) The alcohol solution will remove any sludge deposits which may have coated the stylus tip. The brush bristles should be trimmed to a length no longer than 6 mm (1/4 inch). Always brush the stylus with a forward movement from the rear (terminal end of the cartridge) to the front. Never brush or wipe the stylus from front to back or side to side. NOTE: All Shure styli may be cleaned this way. For other brands of styli, obtain manufacturer's procedure before using the alcohol solution, as permanent damage may result.

To mount a Shure stylus, depress the spring-loaded lever of the mounting block and carefully insert the metal stylus housing (brass tubing) with the stylus tip upward into the v-shaped groove in the top of the mounting block (see Mounting Block illustration).

To mount other than Shure styli, place a piece of supplied pliable material on the top of the mounting plate opposite the locating pin (see Mounting Plate illustration). Place the stylus (tip upward) on the pliable material with the stylus housing pointing toward the locating pin. Gently press the stylus grip (**not** the housing) down into the pliable material so that the stylus tip is perpendicular to the microscope objective lens.

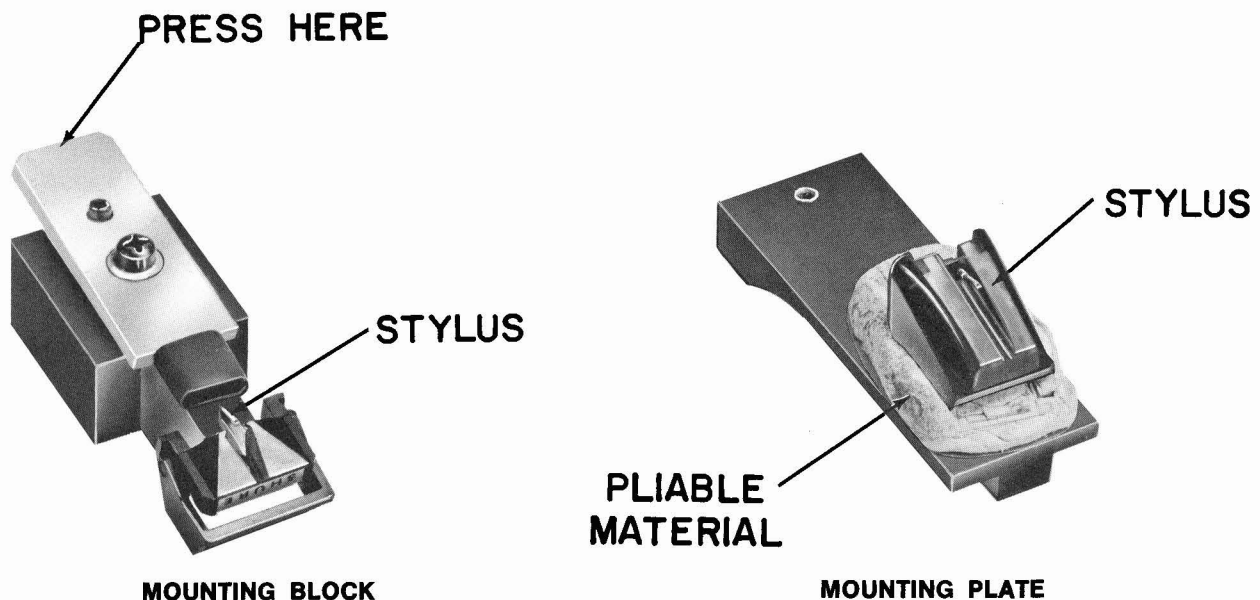

B. Microscope Set-up

1. Place the microscope on a clean workbench or other firm surface and install the lens barrel.
2. Lower the microscope stage by turning the black focus knob at either side of the vertical stand.
3. Install the lamps in the lamp assembly. With the lamps pointing downward, snap the lamp assembly over the vertical body tube and slide the assembly upward as far as it will go.
4. Plug the line cord into a 120 Vac, 50/60 Hz outlet.* Rotate the line cord switch to ON. Both lamps should light. (NOTE: Replace defective lamps with Type 6S6 — 6W, 120V, candelabra base; testing cannot be performed unless both lamps are lit.)
5. If a Shure stylus is to be inspected, place the mounting block with stylus on the microscope stage. With the mounting block centered between the two raised socket-head capscrews and the mounting block pin located in the hole in the platform, the stylus tip should be almost directly below the objective lens.
6. If other than a Shure stylus is to be inspected, place the mounting plate with stylus on the microscope stage. With the mounting plate centered between the two raised socket-head capscrews and the mounting plate pin located in the hole in the stage, the stylus tip should be positioned near the objective lens.
7. If a cartridge with a non-replaceable stylus is to be evaluated, first determine whether the stylus tip, when the cartridge is lying upside-down on the stage, will be perpendicular to the objective lens. If it is perpendicular, proceed to step 8. If it is not, place the cartridge on top of a small piece of supplied pliable material on the mounting plate and gently press the cartridge body down until the stylus tip is perpendicular to the objective lens.
8. Turn the eyepiece zoom control to 10 (100x magnification) and use the x- and y-positioning knurled knobs to center the stylus tip in the eyepiece. The most convenient method of positioning the stylus is to shine the beam of the pencil-type flashlight down through the eyepiece to the stage. The stylus should be moved, using the x- and y-positioning controls, until the beam shines directly on the stylus tip. NOTE: Left to right and front to back movements are reversed when viewed through the eyepiece.
9. Using the black focus control at either side of the vertical stand, bring the stylus tip to within 3 mm ($\frac{1}{8}$ in.) of the objective lens. CAUTION: Do not allow the stylus tip to touch the objective lens, as the diamond tip will scratch the glass. Adjust the microscope focus control to bring the tip into focus. When in focus, the stylus tip should be approximately 6 mm ($\frac{1}{4}$ in.) from the objective lens.
10. Rotate the eyepiece zoom control to 12 (120x magnification).

*See ADDENDA for information on 240-volt operation.

III. STYLUS EVALUATION

Once the stylus tip is in focus, wear spots should be visible which correspond to the points of contact of the record surface. At 120x magnification, the wear spots **and** the stylus tip are both in focus, resulting in so-called “cat’s eyes” where wear has occurred. Figures 1 through 4 illustrate the following stylus conditions at this magnification:

- Figure 1A. Good spherical stylus
- Figure 1B. Worn spherical stylus
- Figure 2A. Good elliptical stylus
- Figure 2B. Worn elliptical stylus
- Figure 3A. Good hyperbolic stylus
- Figure 3B. Worn hyperbolic stylus
- Figure 4A. Good hyperelliptical stylus
- Figure 4B. Worn hyperelliptical stylus

IMPORTANT: New and used styli appear similar when casually observed. Study the wear areas of new and used styli in the microscope and compare them with Figures 1 through 4. Note that the figures show the entire stylus tips in three-dimensional views. In the microscope, only a small portion of the tip — the tip wear area — is in focus at one time. The wear area appears as a flat, two-dimensional representation (as in Figures 5 through 8). This is due to the depth of field limitation and illumination of the microscope.

Increase the eyepiece zoom control to 20 (200x magnification) and refocus as necessary. Figures 5 through 8 illustrate the following stylus conditions at this magnification:

- Figure 5A. Good spherical stylus
- Figure 5B. Slightly worn spherical stylus (recheck within 100 hours of operation)
- Figure 5C. Badly worn spherical stylus (DO NOT USE — will damage records)
- Figure 6A. Good elliptical stylus
- Figure 6B. Slightly worn elliptical stylus (recheck within 100 hours of operation)
- Figure 6C. Badly worn elliptical stylus (DO NOT USE — will damage records)
- Figure 7A. Good hyperbolic stylus
- Figure 7B. Slightly worn hyperbolic stylus (recheck within 100 hours of operation)
- Figure 7C. Badly worn hyperbolic stylus (DO NOT USE — will damage records)
- Figure 8A. Good hyperelliptical stylus
- Figure 8B. Slightly worn hyperelliptical stylus (recheck within 100 hours of operation)
- Figure 8C. Badly worn hyperelliptical stylus (DO NOT USE — will damage records)

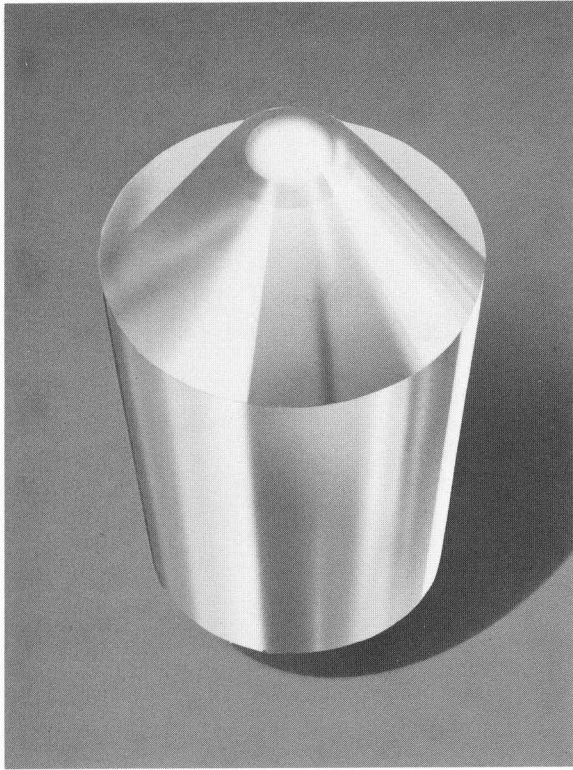

GOOD SPHERICAL STYLUS
FIGURE 1A

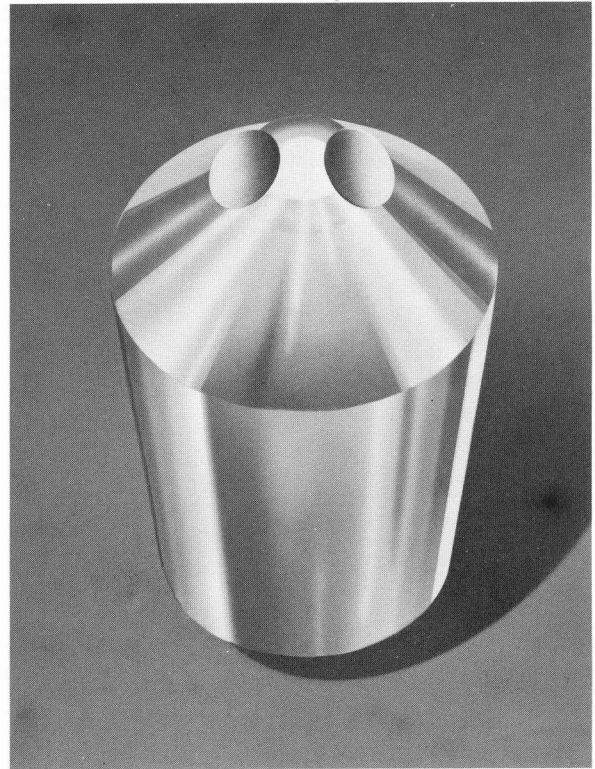

WORN SPHERICAL STYLUS
FIGURE 1B

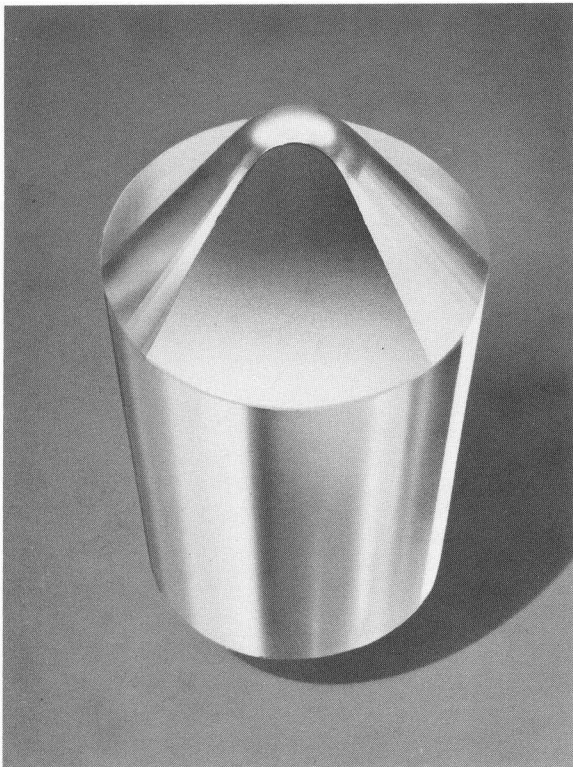

GOOD ELLIPTICAL STYLUS
FIGURE 2A

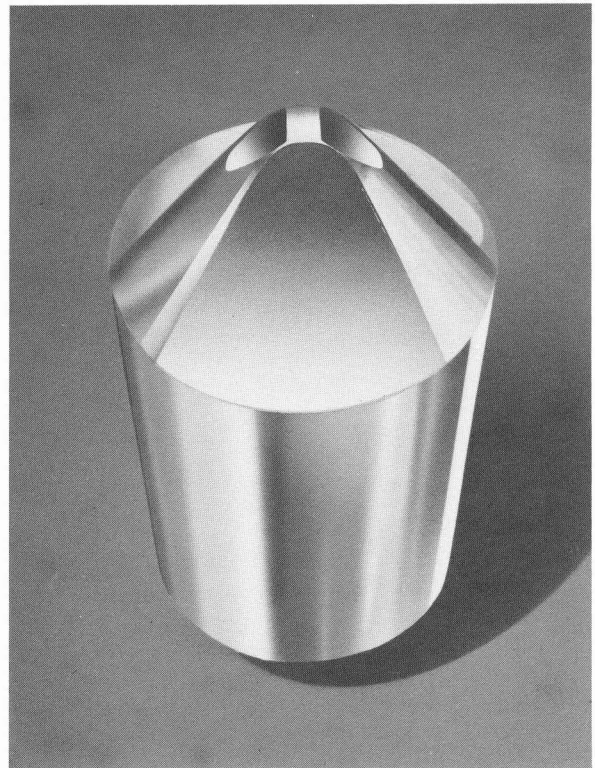

WORN ELLIPTICAL STYLUS
FIGURE 2B

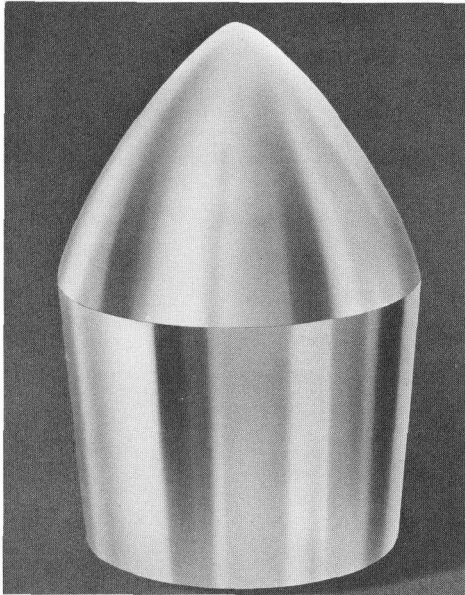

GOOD HYPERBOLIC STYLUS
FIGURE 3A

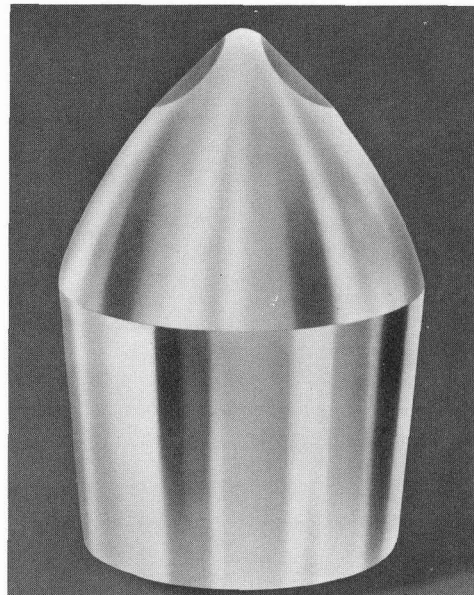

WORN HYPERBOLIC STYLUS
FIGURE 3B

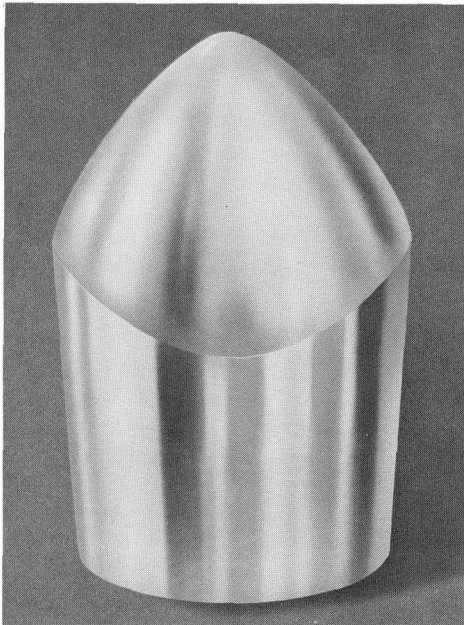

GOOD HYPERELLIPTICAL STYLUS
FIGURE 4A



WORN HYPERELLIPTICAL STYLUS
FIGURE 4B

A good reference check on stylus condition is to use a new replacement stylus as a standard. With the new stylus as a reference, it is easier to evaluate the condition of the used stylus. Another useful test in demonstrating stylus wear to a customer is to maintain a selection of new and worn styli near the microscope so the customer can readily compare his own stylus with both photos and actual styli.

Remember that stylus wear is a continuing, not an overnight, process. A stylus used for only a relatively short time (a few hundred hours) will have small wear spots. However, this does not mean that it must be replaced. After gaining some experience with various degrees of wear, it will become easier to make assessments of styli conditions. Note that there may be bubbles or crystal structure on the stylus shank; these are not important, as **only the stylus tip touches the record.**

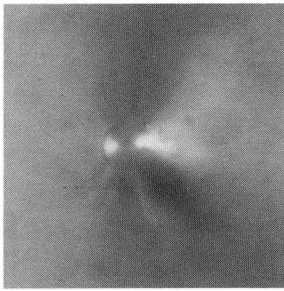

GOOD SPHERICAL
STYLUS
FIGURE 5A

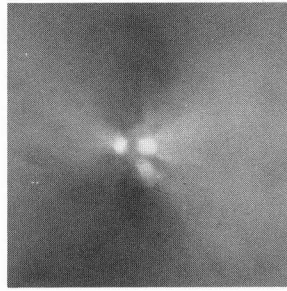

SLIGHTLY WORN
SPHERICAL STYLUS
FIGURE 5B

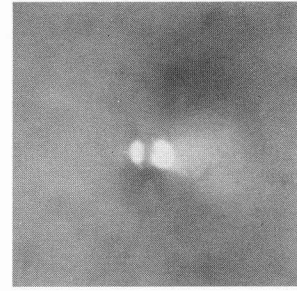

BADLY WORN
SPHERICAL STYLUS
FIGURE 5C

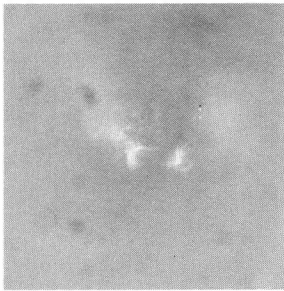

GOOD ELLIPTICAL
STYLUS
FIGURE 6A

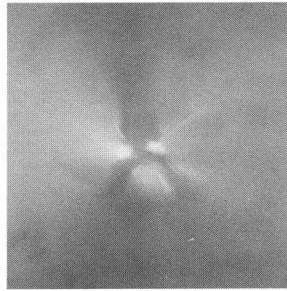

SLIGHTLY WORN
ELLIPTICAL STYLUS
FIGURE 6B

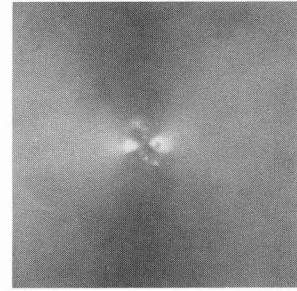

BADLY WORN
ELLIPTICAL STYLUS
FIGURE 6C

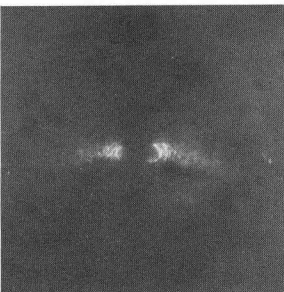

GOOD HYPERBOLIC
STYLUS
FIGURE 7A



SLIGHTLY WORN
HYPERBOLIC STYLUS
FIGURE 7B

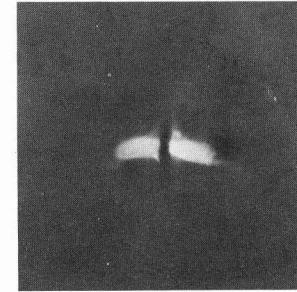

BADLY WORN
HYPERBOLIC STYLUS
FIGURE 7C



GOOD HYPERELLIPTICAL
STYLUS
FIGURE 8A



SLIGHTLY WORN
HYPERELLIPTICAL STYLUS
FIGURE 8B

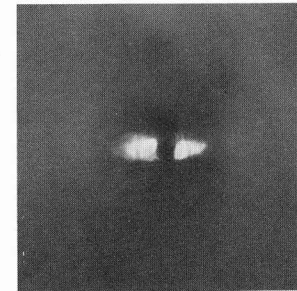

BADLY WORN
HYPERELLIPTICAL STYLUS
FIGURE 8C

IV. STYLUS PRESERVATION

The following recommendations will help the customer to maximize the life of his stylus.

1. Follow the turntable or tone arm manufacturer's instructions when adjusting antiskating force.
2. Do not handle the tone arm while it is in operation. Accidentally touching the tone arm while the turntable is rotating can cause the arm to sweep across the record.
3. If it is necessary to manually place the tone arm in the record groove while the turntable is rotating, be sure to release it as soon as the Dynamic Stabilizer sets down on the record or as the stylus engages the record groove.
4. Correct any improper setdown adjustment or malfunction of the turntable changing mechanism to prevent the stylus from striking the edge of the turntable or the record.
5. Take care to properly insert the stylus into the cartridge assembly and the cartridge and shell assembly into the tone arm receptacle.
6. Use proper vertical tracking force setting for each cartridge. Misadjustment of the tone arm counterbalance can cause excessive vertical force beyond specified limits.
7. Do not use damaged records.
8. When dusting the turntable, be sure to protect the stylus with the stylus guard or Dynamic Stabilizer.

V. ADDENDA

A. Replacement Parts

| | |
|-------------------------|----------|
| Lamp Assembly | 90A2300 |
| Mounting Block | 90A2303 |
| Mounting Plate | 90A2305 |
| Pliable Material | 80A220 |
| Lamp* | 95A486 |
| Lamp Diffuser (2) | 90LE1371 |
| Flashlight | 80A309 |

*Available commercially as Type 6S6 (6W, 120V, candelabra base).

B. 240-Volt Operation

The SEK-2 lamp assembly is supplied wired for 120-volt operation. To provide for operation at 240 Vac, rewire the lamp assembly placing the lamps in series as follows. (NOTE: Rewiring should be performed by qualified service personnel.)

1. Cut or disconnect the lamp wiring at points marked "X" in wiring diagram below.
2. Connect a jumper wire as indicated by dash line in diagram.
3. Remove present plug and connect 240-volt plug.

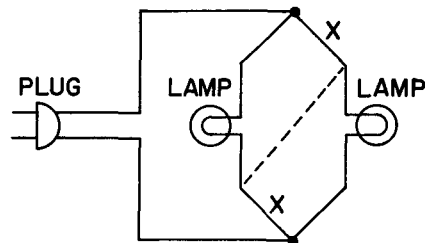

C. Guarantee

This Shure product is guaranteed in normal use to be free from electrical and mechanical defects for a period of one year from the date of purchase. Please retain proof of purchase date. This guarantee includes all parts and labor. This guarantee is in lieu of any and all other guarantees or warranties, express or implied, and there shall be no recovery for any consequential or incidental damages.

D. Shipping Instructions

Carefully repack the unit and return it prepaid to:

Shure Brothers Incorporated
Attention: Service Department
1501 West Shure Drive
Arlington Heights, Illinois 60004

If outside the United States, return the unit to your dealer or Authorized Shure Service Center for repair. The unit will be returned to you prepaid.